

MiCOM Agile P541 & 542



High-speed current differential unit protection

The P54x is designed for all overhead line and cable applications, as it interfaces readily with the longitudinal (end-end) communications channel between line terminals. The interface options support direct fibre optic, or multiplexed digital links. The P541-P542 range offers differential main protection and back-up protection, with auto-reclosure function available in P542

Tripping uses a proven characteristic comparing differential current with through current, for ease of testing. Phase differential elements of this type offer consistent detection of solid and resistive faults, with optimum faulted phase selection, tripping, and indication.

A full range of back-up protection is integrated. This enhances the dependability of the protection, as hot-standby elements (such as overcurrent) can be brought into service whenever a signalling channel outage may occur.

Key Features

Current Differential Protection

- Per phase measurement - accurately identifies the faulted phase
- Applicable to all lines and cables, long or short, strong and weak infeeds
- Phase selectivity without compromise on resistive fault sensitivity

Multi-terminal applications - each relay equipped for 2 or 3 ended schemes

Readily Interfaces with End-to-End Communication Channels

(56/ 64 Kbps or E1 2 Mbps)

- Direct fiber optic communication (up to 130 km)
- IEEE C37.94 TM Standard multiplexed link
- G.703, V.35 and X.21 multiplexed links
- Full health monitoring of the link, with logging of the vital channel statistics

Extensive back-up protection facilities:

- Overcurrent, breaker failure and thermal protection

Multi-shot autoreclosure with check synchronism (P542)

Key Benefits

- Adapted to suit many different substation and protected unit topologies:
 - In-zone transformer-feeder applications
 - Compensates for line CT ratio mismatches
- Programmable scheme logic: Customizes the device to meet the exact protection and control scheme requirements of the bay
- Highly selective unit protection
- Extensive health monitoring for the communications channel
- Integrated back-up elements running hot standby in the event of comms channel outaged



Functional Overview

ANSI	Features	P541	P542
87	Phase segregated current differential	•	•
	2 and 3 terminal lines/cables	•	•
	Feeders with in-zone transformers	•	•
	Direct/permissive intertripping	•	•
	3 pole tripping only	•	•
79	Autoreclose - shots supported		4
50/51	Non-directional phase overcurrent	•	•
49	Thermal overload	•	•
BC	Broken conductor	•	•
	Circuit Breaker condition monitoring	•	•
50 BF	High speed breaker fail	•	•
	Graphical Programmable Scheme Logic (PSL)	•	•
TCS	Trip circuit supervision	•	•
	Alternative setting groups	4	4
	Opto coupled logic inputs	8	16
	Relay output contacts	7	14

Application

Introduction

The P541 and P542 models are applied where no voltage transformer connection is wanted. These devices are limited to three pole tripping only. P543-P546 transmission-oriented models offering options such as subcycle distance zones, distance to fault, single pole tripping and reclose, IEC 61850 ethernet, and support of SONET/SDH multiplexes also exist. These models are covered in a separate brochure for P543 to P546.

The P54x series is supplied with a full suite of protection and control functions as standard. The configuration column of the menu is used to control which functions the user requires in the intended application, and which may be disabled. Disabled functions are completely removed from the menu, to simplify setting. Current differential protection by its nature requires few protection settings, and of those all are generally left at the factory defaults. The P54x series as supplied is ready to protect.

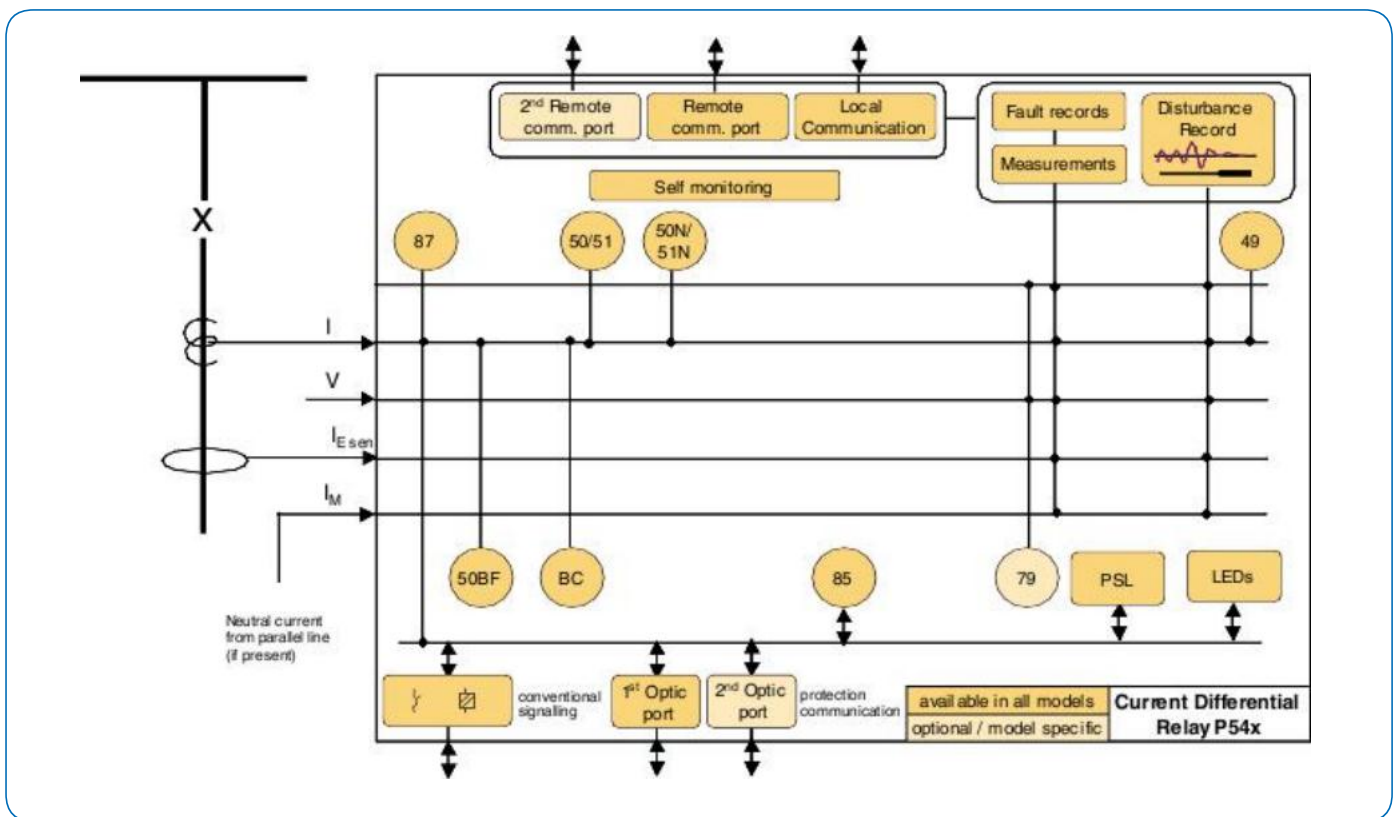

Figure 1 System overview of the P541, P542 series

MiCOM P54x Agile series: unpack,
install, energise - ready to protect

DIFFERENTIAL PROTECTION

The primary protection element in the P54x series is true, phase-segregated current differential protection. The measurement algorithm is extremely reliable, offering fast detection of internal faults, and stability for external faults. The differential algorithm has a dual slope percentage bias restraint, as shown in Figure 2. An internal fault will generate differential current.

The bias current is that which merely flows through the protected unit, as a load or through-fed external fault. The initial slope (k1) ensures sensitivity to low current faults, whereas the k2 slope is raised - to counter the effects of current transformer saturation.

Plotting the trip characteristics in the differential plane assists easy testing/commissioning, and to clearly visualize the exact current sensitivity of the scheme. The excellent performance for high resistance and weak infeed faults is clear - unlike characteristics operating in other planes, whereby their true sensitivity maybe hidden from view.

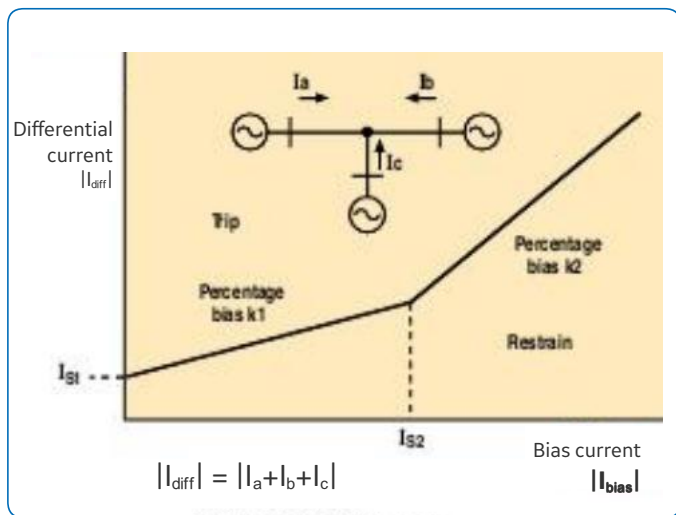

Figure 2 Biased current differential protection

$$|I_{diff}| = |I_a + I_b + I_c|$$

$$|I_{bias}| = 0.5(|I_a| + |I_b| + |I_c|)$$

The relay operates when

- (1) For $|I_{bias}| < I_{S2}$
 $|I_{diff}| > k_1 |I_{bias}| + I_{S1}$
- (2) For $|I_{bias}| > I_{S2}$
 $|I_{diff}| > k_2 |I_{bias}| = (k_2 - k_1) I_{S2} + I_{S1}$



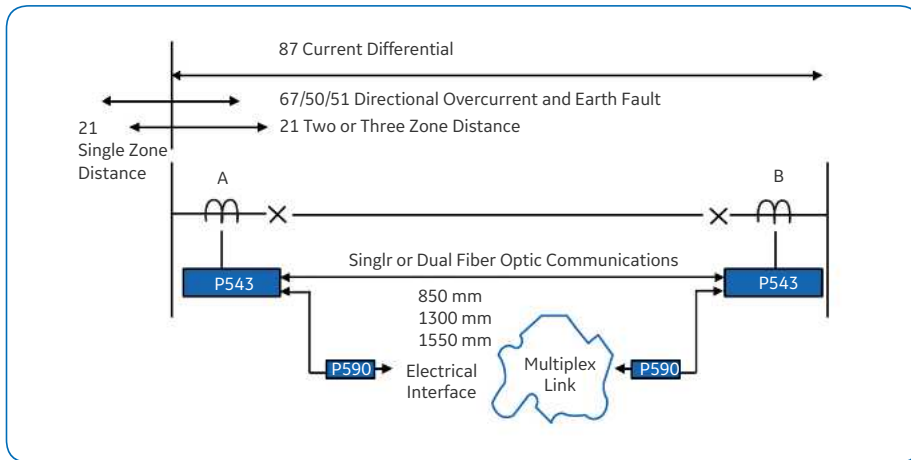

Figure 3a Application to 2 terminal lines

Longitudinal Signaling Topology

Differential protection requires the transfer of current vectors between all ends of the scheme. Figures 3a - 3d show typical configurations. Figure 3a shows a HV/EHV scheme where either a direct fibre optic or a multiplexed link may be used as the chosen channel. Figure 3b shows the triangulated connection required in 3-terminal applications.

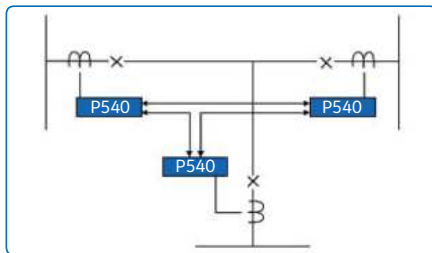

Figure 3b Upgrade to 3 terminal lines

Figure 3c shows a simple direct connection between relays, using a fibre pair.

Figure 3d shows a multiplexed application, where a P54x can be connected directly via fibre optics to an IEEE C37.94™ compliant multiplexer (MUX), or where a MiCOM P59x interface unit performs the optical-electrical conversion for the MUX.

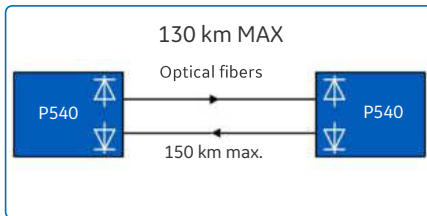

Figure 3c Direct link using optical fibre

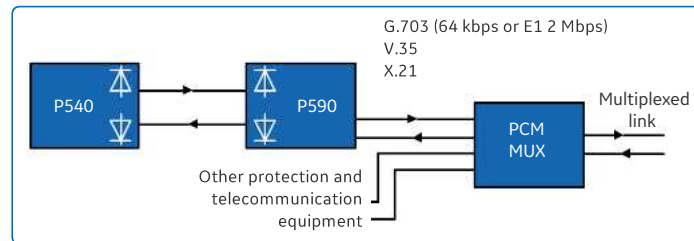
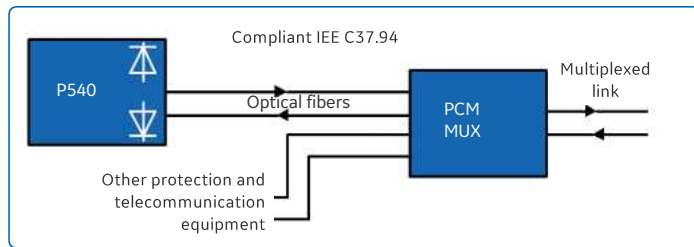

Figure 3d Multiplexed link - relay connected to a remote PCM multiplexer using optical fibre (IEEE C37.94™ compliant MUX) and via a P590 interface unit

System Application Examples

Transformer

Figure 4 shows a protected line and transformer unit. In such applications, P543 and P545 compensate for the vector group shift and zero sequence filtering effects of the in-zone transformer. Second harmonic restraint or blocking is used to stabilise the protection against magnetising inrush currents. A fifth harmonic blocking feature can also be used to inhibit the differential protection during transformer overfluxing conditions.

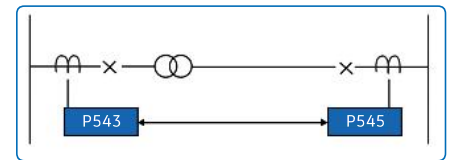

Figure 4 Application to transformer feeders

Where transformer loads are tapped off the protected line, it is not essential to install CTs at the tap. There exists the facility to time grade the differential protection with downstream relays or fuses. The internal autoreclose function can be used to implement fuse-saving schemes in the latter case, improving supply availability.

Network Extensions

All P54x models offer application to two, and three terminal lines. A two terminal scheme is easily reconfigured if a new tee connection is added as a third end.

The P54x compensates for line CT ratio mismatches, even for 1A and 5A differences between line ends. This facilitates easier retrofitting, and network extensions.

Intertripping and other end-end signalling
The P54x series includes additional programmable signals which are transmitted longitudinally, along with the differential messaging. Up to 8 binary commands are available between ends, typically used for intertripping, breaker fail backtripping etc.

Protection Communications

Communication interfacing

To ensure compatibility with standard communication equipment, the P54x series is designed to work within the bandwidth of a 56/64 kbit/s pulse code modulation (PCM) channel. A direct fibre optic connection to a MUX can be done if the MUX is IEEE C37.94 TM compliant. Also electrical interfaces conforming to ITU-T G.821 recommendations for V.35, G.703 (64 Kbps or 2 Mbps E1), and X.21 are available via the P59x series of interface units.

In direct fibre optic applications, 1300 nm and 1550 nm channel options are available. The transmitters are designed with an "optical budget" to support many kilometres of fibre losses, as in the table below.

Relay Comms Options

850 nm multi-mode (to MUX)	50
1300 nm single-mode	50
1300 nm single-mode	100
1550 nm single-mode	130

Differential protection calibrated in the differential plane
No compromise on sensitivity

Communications Supervision

Dependable communications are essential for highperformance differential protection. Each active longitudinal channel is independently monitored, and reports error statistics in line with guidance from ITU-T G.821. Various means exist to implement "hot-standby" protection in the event of degraded communications. Dual redundant communications channels could be considered, whereby there are duplicated links, via diverse communications paths. In such instances, CH1 and CH2 protection channels will both be used. Alternatively, back-up distance or overcurrent elements can be switched into service (either as permanent parallel main protection, or temporary protection only during channel outages).

General Back-up Protection

Overcurrent Protection

Four stages of both phase and earth (ground) fault protection are provided with a choice of standard IDMT curves (Figure 5). Sensitive earth fault is also available.

Broken Conductor

This protection detects the percentage phase unbalance due to an open phase condition.

Thermal Overload

A thermal replica provides alarm and trip stages, to warn and protect in case of thermal overload.

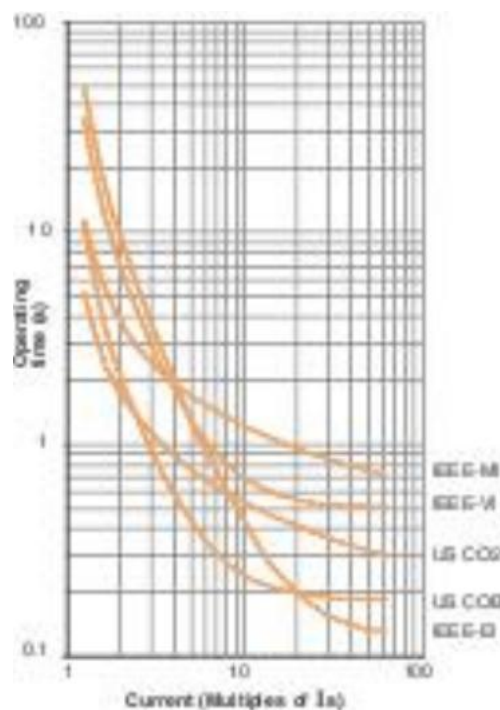
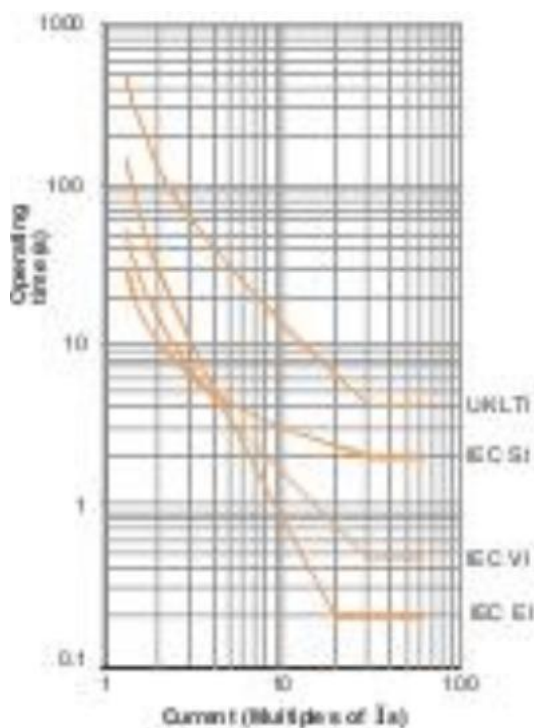

Figure 5 IEC & IEEE/ANSI IDMT

Supervisory Functions

High Speed Breaker Failure

Two stage circuit breaker failure protection for backtripping upstream circuit breakers, and re-tripping of the local circuit breaker if required.

Control

Hotkey Menu

Trip and close commands are facilitated from front panel "hotkeys", to allow direct CB control without the need to navigate a menu. Other in/out, on/off and enable/disable controls are easily programmed.

Autoreclose with Check Synchronism

The user may select a single, two, three or four shot autoreclose cycle.

Programmable Scheme Logic (PSL)

Powerful graphical logic allows the user to customize the protection and control functions (See Figure 6). The gate logic includes OR, AND and MAJORITY gate functions, with the ability to invert the inputs and outputs, and provide feedback.

The system is optimized to ensure that the protection outputs are not delayed by the PSL operation. The programmable scheme logic is configured using the graphical MiCOM S1 Agile software (see Figure 7). The relay outputs may be configured as latching (e.g. "Lockout") or self-reset.

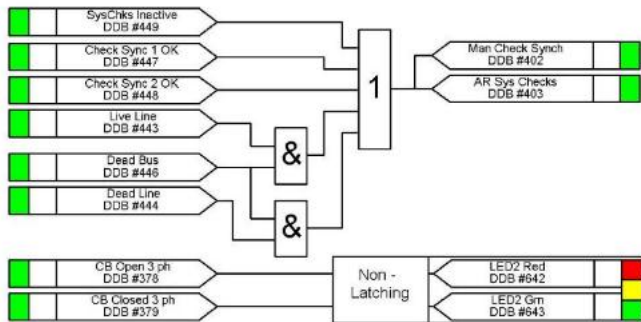

Figure 8 Programmable scheme logic

User Interface

The user interface and menu text are available in English, French, German and Spanish as standard. The ability to customise the menu text and alarm descriptions is also supported.

Password Protection

Password protection may be independently applied to the front user interface, front communications port and rear communications port. Two levels of password protection are available providing access to the controls and settings respectively.

Measurement and Recording Facilities

All event, fault and disturbance records are time tagged to a resolution of 1 ms. An optional IRIG-B port is available for accurate time synchronisation.

Power System Measurements

Instantaneous and time integrated voltage, current and power measurements are provided. These may be viewed in primary, or secondary values.

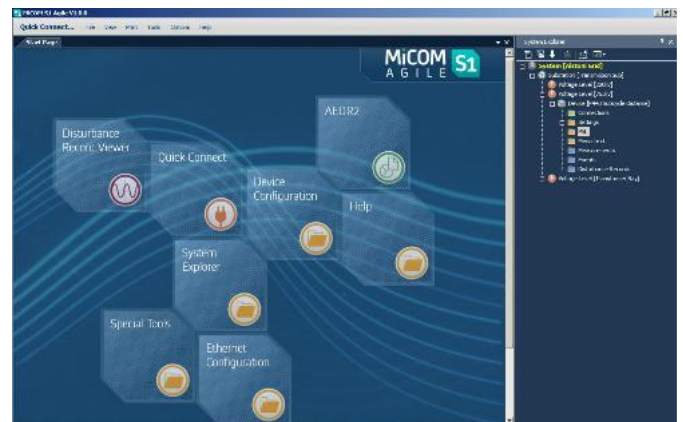

Figure 9 S1 Agile a powerful and intuitive PC tool suite

Post-Fault Analysis

Event Records

Up to 500 time-tagged event records are stored in battery backed memory.

Fault Records

The last 5 faults are stored:

- Indication of the faulted phase
- Protection operation
- Active setting group
- Relay and CB operating time
- Pre-fault and fault currents, and frequency

Disturbance Records

The oscillography has 8 analog channels, 32 digital and 1 time channel. Disturbance records can be extracted from the relay via the remote communications and saved in the COMTRADE format, ready for viewing.

Plant Supervision

Trip Circuit Supervision

Supervision of the trip circuit can be implemented using optocoupled inputs and the programmable scheme logic.

CB State Monitoring

An alarm will be generated if there is a discrepancy between the open and closed CB auxiliary contacts

Circuit Breaker Condition Monitoring

- Monitoring the number of breaker trip operations
- Recording the sum of broken current quantity (interruption duty)
- Monitoring the breaker operating time

Remote Auxiliary Communications

Two auxiliary communication ports are available; a rear port providing remote communications and a front port providing local communications. An additional, second rear port can be ordered as an option.

Any of the following listed rear port protocols can be chosen at the time of ordering:

- Courier/K-Bus
- MODBUS
- IEC 60870-5-103
- DNP 3.0
- UCA2

Second Rear COURIER Port

An optional second port is designed typically for dial-up modem access by protection engineers/operators, when the main port is reserved for SCADA traffic.

Quality Built-in (QBi)

GE's QBi initiative has deployed a number of initiatives to maximise field quality. Harsh environmental coating is applied to all circuit boards to shield them from moisture and atmospheric contamination. Transit packaging has been redesigned to ISTA standards and the third generation of CPU processing boosts not only performance, but also reliability.



P54x in Case Size 80TE

Picture on page 1: Case size 40TE (8")

All your main and backup
protection in one device

Device Track Record - High Speed Distance Protection

LFCB digital current differential protection launched in 1986 Class-leading protection applied at all voltage levels

MiCOM Agile P54x series introduced in 1999.

Worldwide application, with over 25,000 units delivered

56/64 kbit/s teleprotection proven in over 30,000 LFCB and P540 series units delivered

MICOM P40 AGILE

GE's philosophy is one of continuous improvement in our products and solutions. Our emphasis on communication in MiCOM has become a focus which secures leadership in the digital substation. To mark this phase of evolution, the P40 Agile livery is applied to the range. P40 Agile is a mark of performance and quality, proudly available from GE, and only from GE.



For more information please contact
GE Energy Connections
Grid Solutions

Worldwide Contact Center

Web: www.GEGridSolutions.com/contact
Phone: +44 (0) 1785 250 070

GEGridSolutions.com

IEC is a registered trademark of Commission Electrotechnique Internationale. IEEE is a registered trademark of the Institute of Electrical Electronics Engineers, Inc. Modbus is a registered trademark of Schneider Automation.

GE and the GE monogram are trademarks of General Electric Company.

GE reserves the right to make changes to specifications of products described at any time without notice and without obligation to notify any person of such changes.

P541_2-Brochure-EN-2018_08-Grid-GA-0670. © Copyright 2018, General Electric Company. All rights reserved.



Imagination at work